

# HIGH LIGHTS 2023



**OCTANORM** ®

A glowing blue and purple circular ring is positioned on the right side of the image, partially cut off by the edge. The ring has a bright blue inner glow and a purple outer glow, creating a vibrant, futuristic effect against the black background.

GAT  
TH  
FUT

A glowing purple circular ring is positioned on the left side of a black background. The ring has a bright purple inner edge and a darker purple outer edge, creating a glowing effect. Inside the ring, the text "E TO HE URE" is written in a white, sans-serif font, arranged in three lines: "E TO" on the top line, "HE" on the middle line, and "URE" on the bottom line.

E TO  
HE  
URE

**WE CREATE SUSTAINABLE  
CONNECTIONS BETWEEN  
OUR EXHIBITION SYSTEMS  
AND PEOPLE AROUND  
THE WORLD.**

# CONTENT

---

EuroShop 2023 Gate to the future	6
OCTAlux Illuminated extrusions	10
OCTAwall pro 80 mm frame system	14
Maxima meets OCTAuniversal Video wall	16
OCTAeco floor Slope edge   Height adjustable   Cfl proofed	18
More product highlights Wallwasher   OCTAlumina door   Extrusion M 260	20
Online shop OCTANORM Online shop   expo.shop	26
SmartPoints Digital solution	30
OSPI Worldwide partner network	32

# SUSTAINABLE CONNECTIONS

## OCTANORM SYSTEMS

REUSABLE

GLOBALLY DISTRIBUTED

COMBINABLE

OVER DECADES

MORE THAN 120 PARTNERS

SYSTEM GROOVE

EXPERTS

VERSATILE

# EUROSHOP 2023

---

When we think about the future, we are thinking about the unknown and new things, but also about our responsibility towards the future generations. For the future of our branch, we do our utmost for sustainable connections.

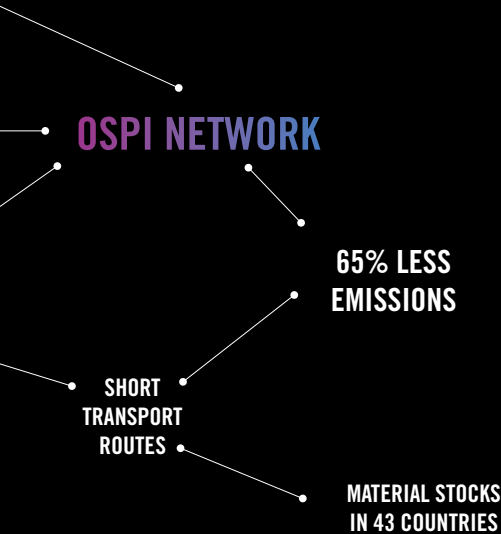

In the exhibition business we guarantee sustainability with our system components which are compatible and can be reused for decades. On the interpersonal level we create sustainable connections with our worldwide exhibition builders network OSPI. In addition, up to 65% of a project's CO<sub>2</sub> emissions can be saved thanks to the OSPI network.

### HANDS-ON-AREA

Samples for illuminated and not illuminated systems, wallwashers used as hanging lamps

### OCTALUX

Presented in different colors

### COMMUNICATION AREA

Bar: ceiling construction out of OCTALumina, round lamps and OCTALux

### RECEPTION

Counter:  
OCTAMesh with OCTALumina dynamic light  
Backwall:  
OCTALumina integrated in OCTAWall pro

### OCTAWALL PRO

Cabin incl. universal door, LED wall, monitor and new quarter-round extrusion

### SUSTAINABILITY

OCTANORM extrusion used since over 46 years



# EUROSHOP 2023

## EXPOMOBIL

Flooring concepts for exhibitions, events and objects

7

## OCTALUMINA PLUS

Cube with two fabric layers, integrated LED stripes, curved LED wall and monitor in the isle

8

9

## ONLINE SHOP

OCTANORM Online shop and expo.shop live

10

## ICT

New multimedia trends

## OSPI NETZWERK

Worldwide partner network  
Exhibits: OCTALumina

## LED VIDEO WALL

3D-Content  
Subconstruction:  
OCTAuniversal and Maxima

**Attractive. Individual. Colorful.**

Illuminated upright and beam extrusions are opening new design worlds and possibilities.

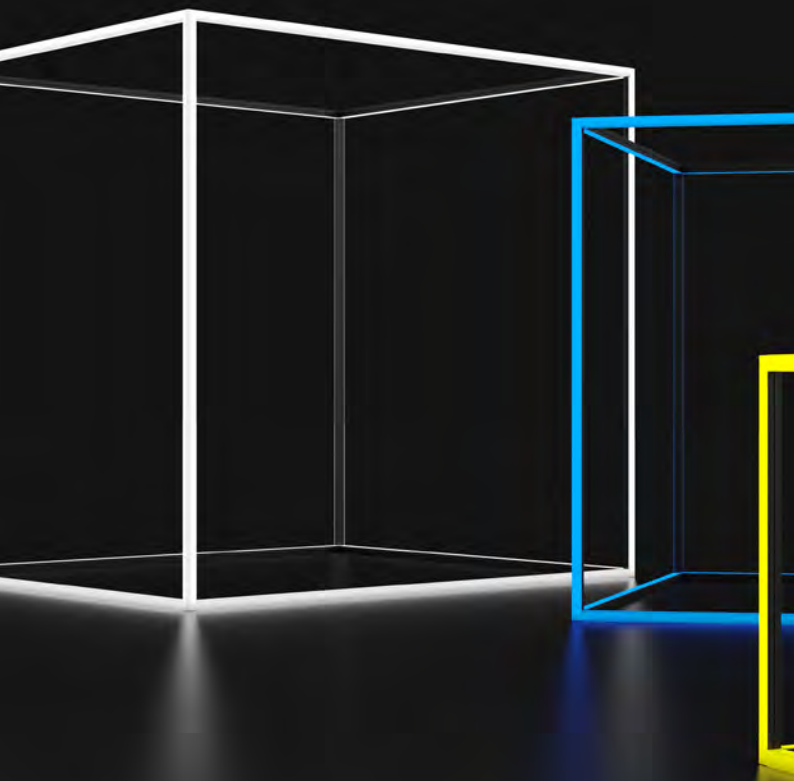

# OCTALUX

## Illuminated extrusions

### **One Design. Many colors. Different impression.**

Each color has its own effect on the viewer. Some colors are activating, others are calming down. With OCTALux this effect can be used on purpose, because the LEDs are offering the complete RGB color spectrum with the possibility of color changes. A system for elegant exhibition booths, shop solutions and energy loaded event spaces. The remote control lies in your hand.

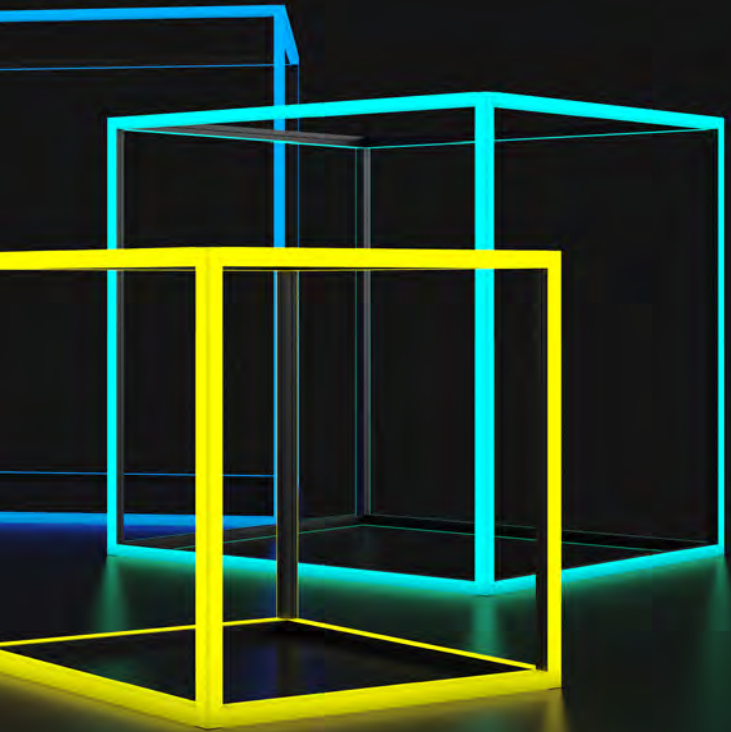

### **Durable and bright: high quality COB LEDs.**

These LEDs are characterized by a higher brightness and a long service life. The individual light points are not visible and ensure an even illumination. COB is short for chip-on-board. The LED technology is integrated into the surface and prevents individual LEDs from detaching.

### **OCTAlux – the plus for several OCTANORM systems.**

A new feature, that is revalorizing existing systems: The basic extrusion is equipped with the well proven OCTANORM system groove on the sides which are not illuminated. Therefore it can be connected ideally with all OCTANORM systems like OCTAwall pro, OCTAlumina and Maxima, but also with OCTAwall 40 and the OCTANORM beam extrusions. A real added value for each designer.



**Two different basic extrusions with one or two illuminated sides.**



**Illuminated surfaces without interruption because of illuminated corners.**

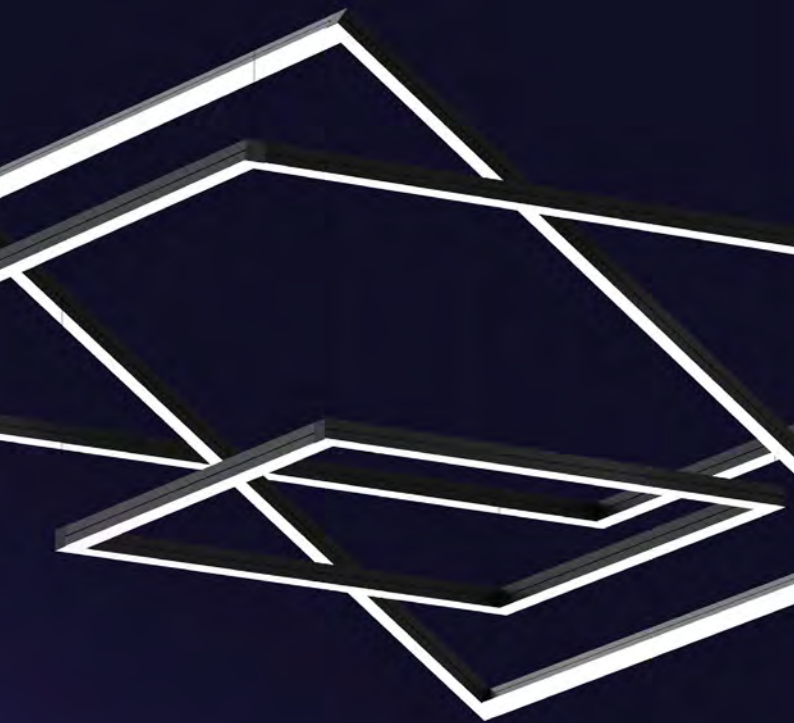

**OCTAlux** suspended  
as ceiling light.

### **Frame system and multimedia talent.**

The concept of the 80 mm frame system is modular and it can be assembled with quick connectors in no time. The straight and curved elements can be combined with Maxima, OCTAwall 40 and OCTAlumina. The cables of integrated monitors or LED tiles are disappearing in the space between two frames.

### **LED videowalls are setting highlights.**

Lively pictures and bright colors: LED tiles are eye-catchers on every exhibition booth. You can use LED tiles from different suppliers, because their standard tiles can be mounted without any problem between the frames. The fixing in the system groove is guaranteeing a tight connection.



**Easy cable management between two frames.**

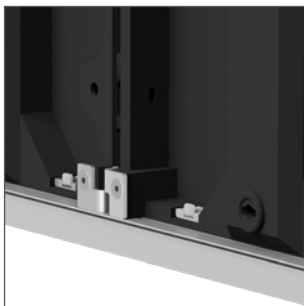

**LED tiles are fixed with adaptors in the system groove.**

# OCTAWALL PRO

80 mm frame system

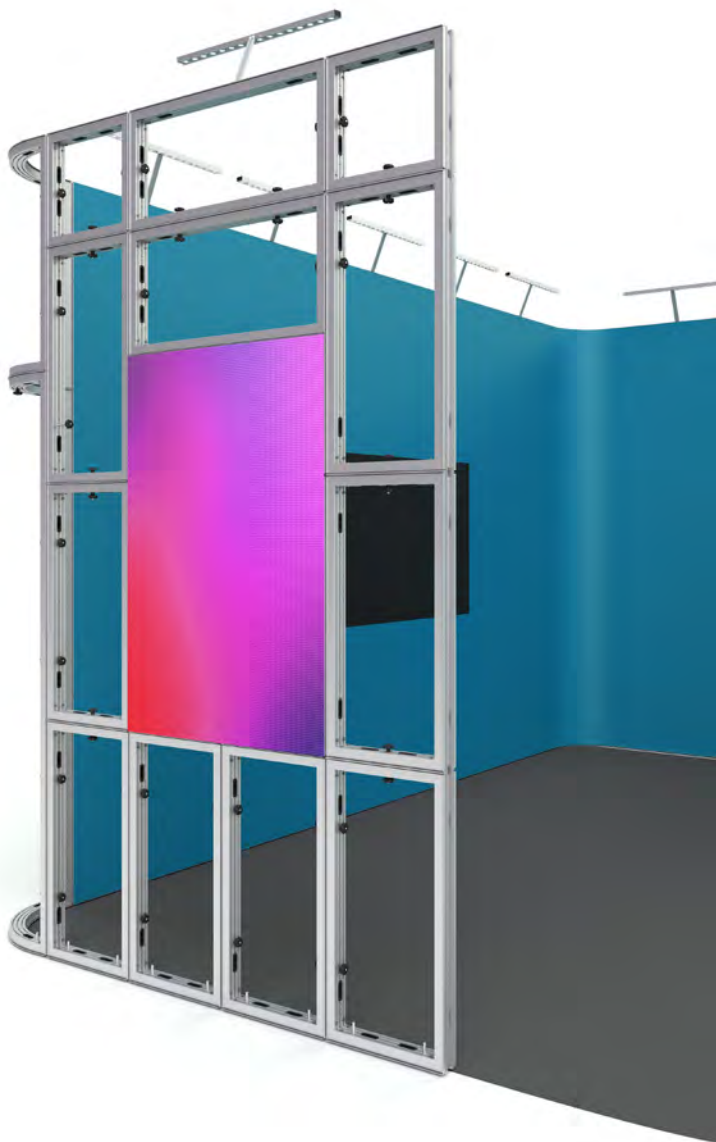





# MAXIMA MEETS OCTAUNIVERSAL

## Video wall

### **LED walls integrated fast and easy!**

Upgrade your Maxima stock with the OCTAuniversal upright extrusion and make your booth even more attractive with impressive video walls. The LED tiles are mounted safely to the extrusions, which are mounted with distance pieces at the OCTAuniversal upright extrusions. And the best is: The adaptors can be mounted at LED tiles of various suppliers! Therefore you are independent with the selection of your LED tiles.

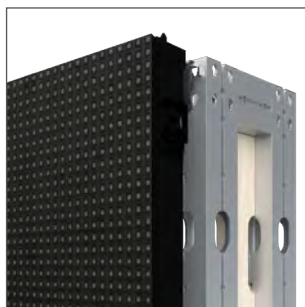

**Adaptors are allowing the integration of LED tiles from different suppliers.**

**Everywhere usable. Cfl-s1 approved.**

Our OCTAeco floor panels are not only weather proven and thus suitable also for the outdoor use, but they are also heavy flammable. With Cfl-s1 they are following all legal requirements and security rules according to the European Norm EN 13501-1.

**More visitors thanks to barrier free access.**

Our slope edge panels are making the exhibition booth easy accessible for all visitors. They can be attached seamless to the normal floor panels. This means: no tripping hazards, no ledges or edges.

**Cable tangle is from now on a foreign word.**

With the stackable adaptors, different heights can be achieved. In the space in between the necessary cables can be layed and can be positioned through cable openings.



# OCTAECO FLOOR

Slope edge | Height adjustable | Cfl approved



Three stacked adapters allow for a maximum overall height of 214 mm.

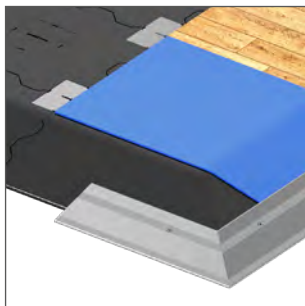

Accessories like perfectly fitting aluminium strips ensure a neat laminate or carpet installation - also for slope edge panels.





# WALLWASHER M 1497

With bracket or suspended

## **Illumination of the entire surface. Over the full height.**

Our wallwasher M 1497 is illuminating equally and without any shadow a surface with a width of 1000 mm and a height of 2500 mm with 3600 lm – without any hotspots. 5700 K are supplying a neutral light color. Up to 5 wallwashers can be connected to one power supply unit. Additionally the brightness can be adjusted with a dimmer.

## **One Light. Two options how to be used.**

The wallwasher can be mounted with a bracket to the system groove, or it can be suspended from the ceiling.

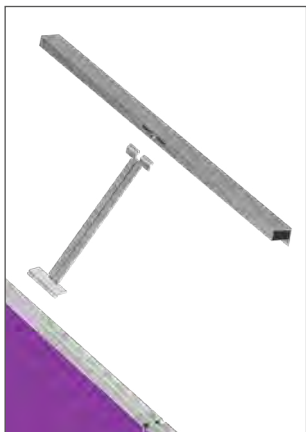

**M 1497: Bracket can be detached for easy storage.**



**M 1497-H: Wallwashers can be connected and suspended.**



Can be mounted between two frames  
or directly to a corner upright extrusion



# OCTALUMINA DOOR OL 1295

Double-sided illuminated

## An illuminated door for OCTALumina 120

Illuminated on both sides and outside mounted flush to the OCTALumina frames. The door element OL 1295 can be mounted between two OCTALumina frames, or directly to a corner upright extrusion. It can be decided freely, if the door shall be mounted as DIN left/right, or if the opening should be to the inside, or the outside. The door element fits to all 120 mm OCTALumina light frames (height 2480 mm).

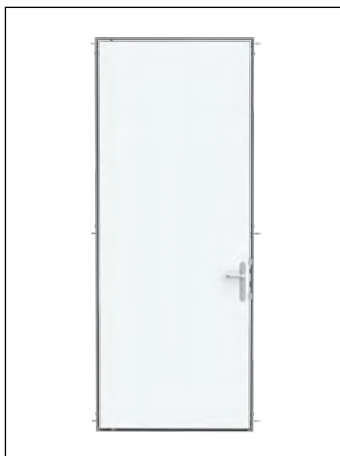

**The illuminated door consists of the frame and the doorleaf.**

### The extrusion for a seamless and soft look.

The perfect combination of two frame elements for all designs with a round shape. With the curved profile M 260 you can create smooth transitions at a 90° angle. Vertically installed as a rounded corner between two wall frames and horizontally as a transition between wall and ceiling frames. The extrusion can also be covered with fabric.

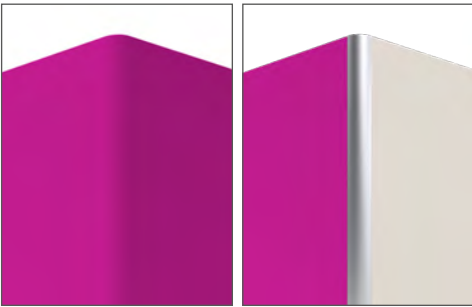

Vertical use: rounded corner upright covered with fabric and without cover

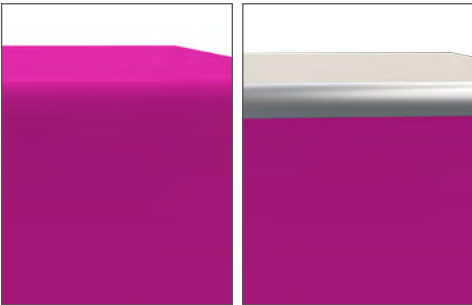

Horizontal use: transition from wall to ceiling covered with fabric and without cover

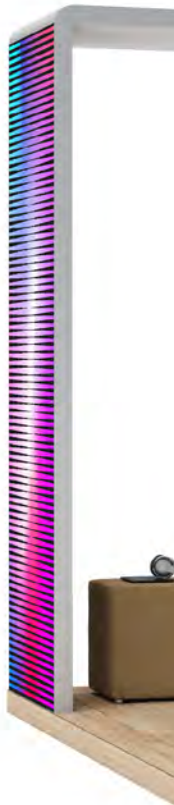



# QUARTER-ROUND EXTRUSION M 260

Vertically | Horizontally

## Universal use.

Because of the proven OCTANORM system groove the extrusion M 260 is compatible with all OCTANORM systems like Maxima, OCTAwall 40, OCTAwall pro and OCTAlumina.





Visit now our  
octanorm.shop

# OCTANORM.SHOP

Online shop for direct OCTANORM customers



## Easy, fast and around the clock ordering.

In our OCTANORM online shop you are receiving all important information for our OCTANORM products. These can be ordered online directly with only a few clicks. Your personal contact person will stay the same.

## Always up-to-date: prices, stock volume and infos.

If the requested article is not available right now, you can send us an inquiry via our form.

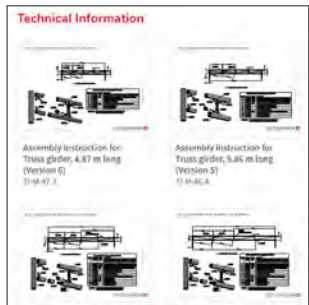

Technical infos are linked directly with the article.

## Extrusion generator

That you will find the requested article faster, we have installed a navigator into our online shop. With the various filter options you can limit the range of articles.



Extrusion generator: with few clicks to the requested extrusion.

# expo.shop

## Everything for the exhibition: Comfortable online shopping.

expo.shop is offering from exhibition systems, furniture, tools to flooring a wide range of articles for your exhibition participation.

## Complete exhibition booth – sets with only one click.

To make the exhibition world easy accessible for everybody, expo.shop is offering a series of ready to build exhibition booth sets. Just select a booth space between 2 m<sup>2</sup> and 24 m<sup>2</sup>, illuminated or without illumination. The offer is completed with individual fabric graphics.

## Competent help locally: the OCTANORM Partner Network.

Our expo.shop network is spread all over Germany. Therefore you will find always a contact person in your neighborhood. And this means perfect service before, during and after placing the order.



Order online: complete booth sets for your exhibition appearance

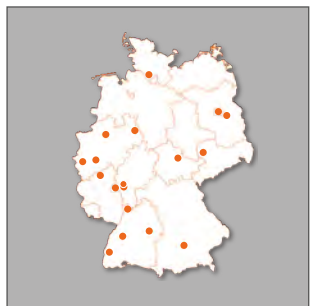

Always in your neighborhood: our german partner network

# EXPO.SHOP

Online shop for german end users

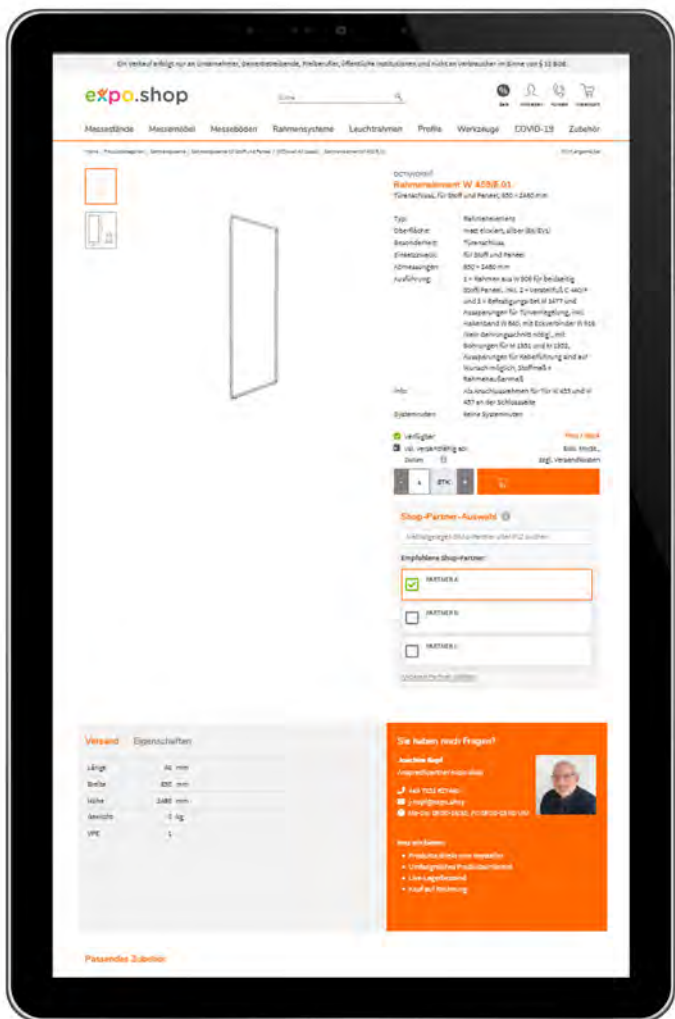

Visit now our  
expo.shop

## **With SmartPoints, communication and advertising materials finally become digital!**

Visitors receive a scancard with which they can individually memorize all the topics or products relevant to them. Using a personalized code, they can then access their memorized information via mobile device or PC.

### **Valuable component for information acquisition**

As a digital solution, SmartPoints is also a valuable component for information acquisition for you as an exhibitor. The SmartPoints data not only shows which topics and products are particularly popular, but also which days and times of the trade show were particularly busy, or which routes visitors preferred to take.

### **Lead generation**

With the optional registration, even qualitative leads can be generated.



**To access the collected topics and products, all you have to do is scan the QR code or enter the URL and ID.**



**Optional registration is available before accessing the content.**

# SMARTPOINTS

## Digital solution



### Advantages for exhibition visitors

- Personalized collection of specific information as an overview
- Quick access to information via QR code
- Application optionally multilingual
- Real-time updating of scans
- Fast distribution to colleagues
- No printed brochures to carry

### Advantages for exhibitors

- Sustainable stand management, by avoiding the use of paper
- Real-time data collection with user's area of interest - anonymous or personalized
- DSGVO-compliant data processing
- Whitelabel solution with own branding
- Individualization according to wishes and requirements are possible

**OCTANORM Service Partner International, so called OSPI –  
The largest and most sustainable exhibition builder  
network worldwide.**

With OCTANORM you are reaching out to a worldwide team of exhibition experts. Your local OSPI is working with a network of more than 120 partners in 43 countries and he is supporting you from the planning to the hand-over of the exhibition booth.

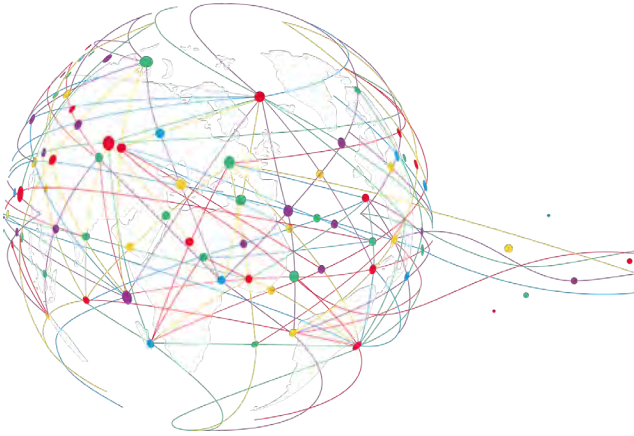

A team which you can trust across borders. According to the motto: “Designed here – built there”. It doesn’t matter where your exhibition booth will have to be build, you can be sure, that your construction plans will be put into reality up to the smallest detail. With the country specific knowhow and the OCTANORM system components.



**Learn more about OSPI:  
[www.ospi-network.com](http://www.ospi-network.com)**



# OSPI

The unique partner network

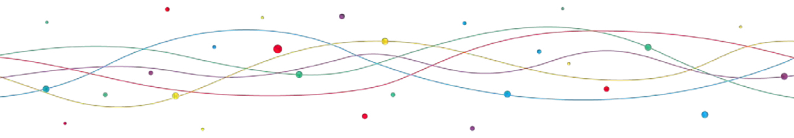

Another plus: over 65% of CO<sub>2</sub> can be saved! How is this possible? Because of the worldwide available partners transports and flights can be avoided, as the construction material and the set-up team is already available at the destination.

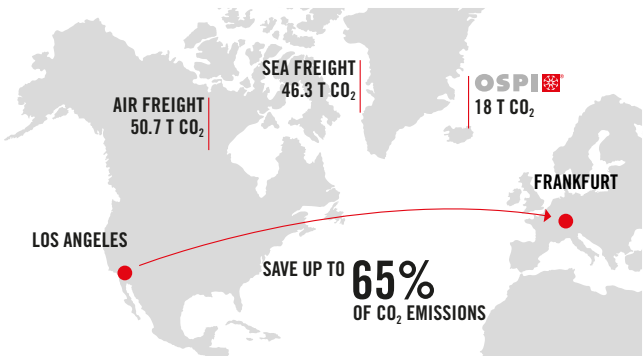



**EXHIBITION SYSTEMS**  
**PROJECT SOLUTIONS**  
**PRESENTATION**  
**INTERIOR DESIGN**  
**CLEANROOM SYSTEMS**

# OCTANORM WORLDWIDE

---

## EUROPE

---

### **OCTANORM® Nordic**

T. +46 8 621 6500

[www.octanorm.se](http://www.octanorm.se)

### **OCTANORM® Polska**

T. +48 22 773 0350

[www.octanorm.pl](http://www.octanorm.pl)

### **OCTANORM® Belgium**

T. +32 475 35 60 76

[www.octanorm.be](http://www.octanorm.be)

### **OCTANORM® France**

T. +33 6 79 11 32 05

[www.octanorm.fr](http://www.octanorm.fr)

### **OCTANORM® UK**

T. +44 20 85 45 2945

[www.octanorm.co.uk](http://www.octanorm.co.uk)

### **OCTANORM® Espana**

T. +34 930 019 424

[www.octanorm.es](http://www.octanorm.es)

### **OCTANORM® Hellas**

T. +30 2310 79 6521

[www.octanorm.gr](http://www.octanorm.gr)

### **OCTANORM® Italia**

T. +39 031 2269715

[www.octsystem.it](http://www.octsystem.it)

### **OCTANORM® Adria**

T. +386 590 56301

[www.octanormadria.com](http://www.octanormadria.com)

## AFRICA

---

### **OCTANORM® South Africa**

T. +27 11 433 2010

[www.octanorm.co.za](http://www.octanorm.co.za)

## AMERICA

---

### **OCTANORM® North America**

T. +1 770 7 32 1520

[www.octanormna.com](http://www.octanormna.com)

### **OCTANORM® México**

T. +52 55 5804 6325

[www.octanorm.com.mx](http://www.octanorm.com.mx)

## ASIA

---

### **OCTANORM® China**

T. +86 512 6283 3336

[www.octanorm.cn](http://www.octanorm.cn)

### **OCTANORM® Japan**

T. +81 45 511 8144

[www.octanorm.co.jp](http://www.octanorm.co.jp)

## AUSTRALIA

---

### **OCTANORM® Australia**

T. +61 3 7017 2753

[www.octanorm.com.au](http://www.octanorm.com.au)

## MIDDLE EAST

---

### **OCTANORM® Emirates**

T. +971 4 340 6888

[www.octanormemirates.net](http://www.octanormemirates.net)

---

**OCTANORM®**-Vertriebs-GmbH  
für Bauelemente  
Raiffeisenstraße 39  
70794 Filderstadt  
T. +49 711 77003-0  
F. +49 711 77003-53  
info@octanorm.de  
www.octanorm.com

AW 2023.GB\_Highlights 2023\_02/2023

**OCTANORM** ®